

gebo®

A316

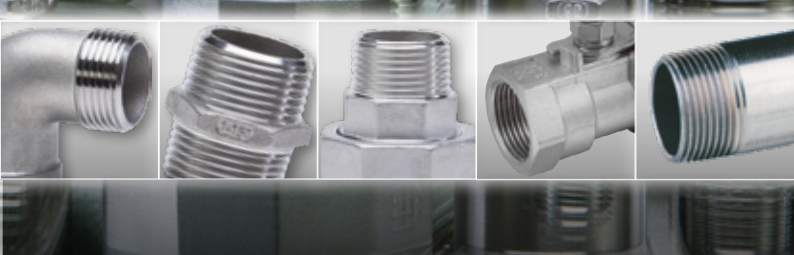

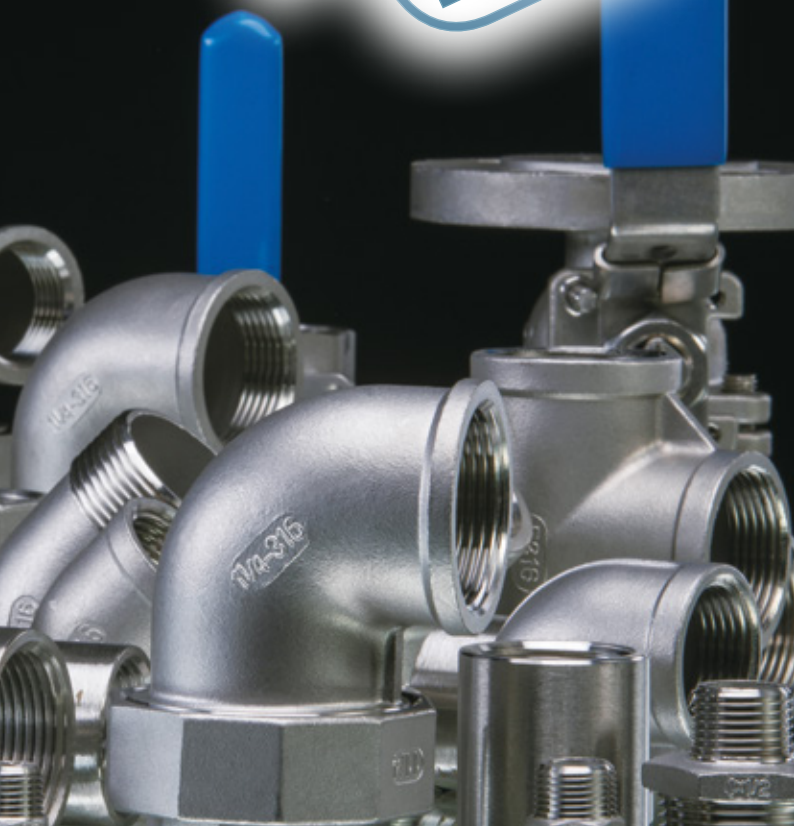

Gewindefittings:

- Alle gegossenen Artikel sind gefertigt aus Material 1.4408
- Legierungsbestandteile in %: C \leq 0,07 · Cr 18,0–20,0 · Ni 9,0–12,0 · Mo 2,0–2,5
- Bogen Art.-Nr. 6003 und Muffen Art.-Nr. 6270 und 6272 sind gefertigt aus Material 1.4404 (AISI 316L)
- Alle flachdichtenden Verschraubungen sind mit einer Dichtung aus PTFE ausgestattet
- Alle Artikel sind gekennzeichnet mit Druckstufe 150 lbs ~ 10,5 bar.
- Die Materialien 1.4408 + 1.4404 sind einsetzbar für die Medien Wasser, Trinkwasser, verschiedenen chemische Substanzen und Nahrungsmittel
- Sehr gute Korrosionsbeständigkeit und Säurebeständigkeit
- Maximale Betriebstemperatur (ohne weitere mechanische Einwirkung von Kräften): 220 °C
- Anschlussgewinde gemäß DIN EN 10226-1 (ISO 7/1)

Seite 175-192



Kugelhähne:

- Alle Grundkörper sind aus dem Material CF8M gefertigt, die Materialien der Einzelteile sind in den Werkstofflisten ab Seite 194 aufgeführt
- Alle Kugelhähne sind mit Dichtungen aus PTFE ausgestattet
- Alle Kugelhähne sind mit der Druckstufenangabe 1000 lbs – 69 bar versehen
- Die Druckstufen und Temperaturverläufe sind den Tabellen ab Seite 194 zu entnehmen
- Einsetzbar für die Medien Wasser und verschiedenen chemische Substanzen
- Sehr gute Säure- und Korrosionsbeständigkeit
- Alle Kugelhähne sind mit einer abschließbaren Schließblase ausgestattet
- Die Gewindeanschlüsse entsprechen der DIN EN 10226-1 (ISO 7/1)

Seite 194-203

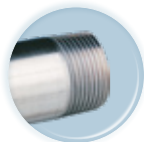

Rohrgewindenippel:

- Rohrdoppelnippel und Nippel mit Anschweißenden sind aus geschweißten Edelstahlrohren (Material 1.4404) nach DIN EN 10255, DIN EN 10241
- Einsetzbar für die Medien Wasser, Trinkwasser und verschiedenen chemische Substanzen
- Druckstufen: max. 50 bar (20 °C)
- Die Gewinde entsprechen der DIN EN 10226-1 (ISO 7/1)

Seite 204-206

3 Langer Bogen 90°, A/A

Mat. 1.4404

Größe [1 x 2]	Artikel-Nr.	Abmessungen [mm]	
		L	
1/4"	6003-014	60,0	
3/8"	6003-038	70,0	
1/2"	6003-012	80,0	
3/4"	6003-034	100,0	
1"	6003-100	120,0	
1 1/4"	6003-114	140,0	
1 1/2"	6003-112	160,0	
2"	6003-200	190,0	

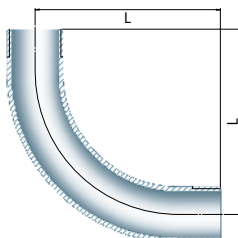

90 Winkel 90°, I/I, beide Seiten gleich

Mat. 1.4408

Größe [1 x 2]	Artikel-Nr.	Abmessungen [mm]	
		L	D1
1/8"	6090-018	17,0	13,0
1/4"	6090-014	19,0	16,0
3/8"	6090-038	23,0	20,0
1/2"	6090-012	27,0	24,5
3/4"	6090-034	32,0	30,0
1"	6090-100	38,0	37,5
1 1/4"	6090-114	45,0	46,5
1 1/2"	6090-112	48,0	53,0
2"	6090-200	57,0	65,5
2 1/2"	6090-212	69,0	82,0
3"	6090-300	78,0	95,5
4"	6090-400	96,0	121,5

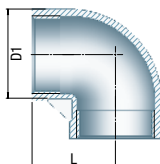

90 Winkel 90°, I/I, reduziert

Mat. 1.4408



Größe [1 x 2]	Artikel-Nr.	Abmessungen [mm]			
		L	L1	D1	D2
1/2" x 3/8"	6090-012038	25,0	26,0	24,5	20,0
3/4" x 3/8"	6090-034038	28,0	28,0	30,0	20,0
3/4" x 1/2"	6090-034012	30,0	29,0	30,0	24,5
1" x 1/2"	6090-100012	33,0	32,0	37,5	24,5
1" x 3/4"	6090-100034	35,0	34,0	37,5	30,0
1 1/4" x 3/4"	6090-114034	40,0	38,0	46,5	30,0
1 1/4" x 1"	6090-114100	42,0	40,0	46,5	37,5
1 1/2" x 1"	6090-112100	45,0	41,0	53,0	37,5
1 1/2" x 1 1/4"	6090-112114	48,0	45,0	53,0	46,5
2" x 1 1/4"	6090-200114	54,0	48,0	65,5	46,5
2" x 1 1/2"	6090-200112	55,0	52,0	65,5	53,0

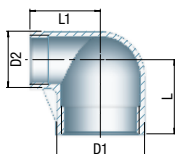

92 Winkel 90°, A/I, beide Seiten gleich

Mat. 1.4408



Größe [1 x 2]	Artikel-Nr.	Abmessungen [mm]	
		L	D1
1/8"	6092-018	17,0	13,0
1/4"	6092-014	19,0	16,0
3/8"	6092-038	23,0	20,0
1/2"	6092-012	27,0	24,5
3/4"	6092-034	32,0	30,0
1"	6092-100	38,0	37,5
1 1/4"	6092-114	45,0	46,5
1 1/2"	6092-112	48,0	53,0
2"	6092-200	57,0	65,5
2 1/2"	6092-212	69,0	82,0
3"	6092-300	78,0	95,5
4"	6092-400	97,0	121,5

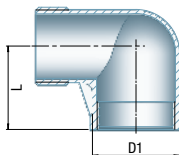

95 Winkelverschraubung 90°, flach dichtend, I/I

Mat. 1.4408

Größe [1 x 2]	Artikel-Nr.	Abmessungen [mm]			
		L	L1	D1	H
1/4"	6095-014	46,5	13,5	16,0	17,0
3/8"	6095-038	51,0	15,0	19,0	20,0
1/2"	6095-012	56,0	16,0	26,0	27,0
3/4"	6095-034	61,0	17,0	31,5	31,0
1"	6095-100	70,5	20,0	39,0	36,0
1 1/4"	6095-114	78,0	22,0	47,5	42,0
1 1/2"	6095-112	83,0	24,0	54,0	46,0
2"	6095-200	96,0	27,0	66,5	56,0

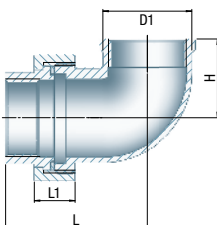

96 Winkelverschraubung 90°, konisch dichtend, I/I

Mat. 1.4408

Größe [1 x 2]	Artikel-Nr.	Abmessungen [mm]			
		L	L1	D1	H
1/4"	6096-014	46,5	13,5	16,0	17,0
3/8"	6096-038	51,0	15,0	19,0	20,0
1/2"	6096-012	56,0	16,0	26,0	27,0
3/4"	6096-034	61,0	17,0	31,5	31,0
1"	6096-100	70,5	20,0	39,0	36,0
1 1/4"	6096-114	78,0	22,0	47,5	42,0
1 1/2"	6096-112	83,0	24,0	54,0	46,0
2"	6096-200	96,0	27,0	66,5	56,0

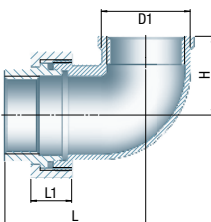

97 Winkelverschraubung 90°, flach dichtend, A/I

Mat. 1.4408



Größe [1 x 2]	Artikel-Nr.	Abmessungen [mm]			
		L	L1	D1	H
1/4"	6097-014	57,0	13,5	16,0	17,0
3/8"	6097-038	62,0	15,0	19,0	20,0
1/2"	6097-012	70,5	16,0	26,0	27,0
3/4"	6097-034	76,5	17,0	31,5	31,0
1"	6097-100	88,5	20,0	39,0	36,0
1 1/4"	6097-114	100,0	22,0	47,5	42,0
1 1/2"	6097-112	103,5	24,0	54,0	46,0
2"	6097-200	121,0	27,0	66,5	56,0

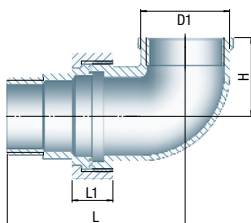

98 Winkelverschraubung 90°, konisch dichtend, A/I

Mat. 1.4408



Größe [1 x 2]	Artikel-Nr.	Abmessungen [mm]			
		L	L1	D1	H
1/4"	6098-014	57,0	13,5	16,0	17,0
3/8"	6098-038	62,0	15,0	19,0	20,0
1/2"	6098-012	70,5	16,0	26,0	27,0
3/4"	6098-034	76,5	17,0	31,5	31,0
1"	6098-100	88,5	20,0	39,0	36,0
1 1/4"	6098-114	100,0	22,0	47,5	42,0
1 1/2"	6098-112	103,5	24,0	54,0	46,0
2"	6098-200	121,0	27,0	66,5	56,0

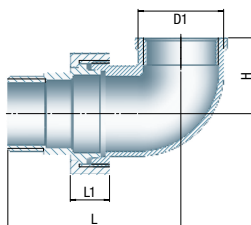

120 Winkel 45°, I/I

Mat. 1.4408

Größe [1 x 2]	Artikel-Nr.	Abmessungen [mm]	
		L	D1
1/8"	6120-018	16,0	13,0
1/4"	6120-014	17,0	16,0
3/8"	6120-038	19,0	20,0
1/2"	6120-012	21,0	24,5
3/4"	6120-034	25,0	30,0
1"	6120-100	29,0	37,5
1 1/4"	6120-114	33,0	46,5
1 1/2"	6120-112	37,0	53,0
2"	6120-200	42,0	65,5

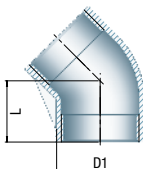

121 Winkel 45°, A/I

Mat. 1.4408

Größe [1 x 2]	Artikel-Nr.	Abmessungen [mm]	
		L	D1
1/4"	6121-014	19,0	16,0
3/8"	6121-038	23,0	20,0
1/2"	6121-012	27,0	24,5
3/4"	6121-034	32,0	30,0
1"	6121-100	38,0	37,5
1 1/4"	6121-114	45,0	46,5
1 1/2"	6121-112	48,0	53,0
2"	6121-200	57,0	65,5

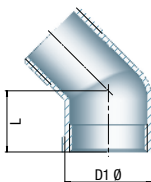

130 T-Stück 90°, I/I/I, 3 Seiten gleich

Mat. 1.4408



Größe [1 x 2]	Artikel-Nr.	Abmessungen [mm]	
		L	D1
1/8"	6130-018	17,0	13,0
1/4"	6130-014	19,0	16,5
3/8"	6130-038	23,0	20,0
1/2"	6130-012	27,0	24,5
3/4"	6130-034	32,0	30,0
1"	6130-100	38,0	37,5
1 1/4"	6130-114	45,0	46,5
1 1/2"	6130-112	48,0	53,0
2"	6130-200	57,0	65,5
2 1/2"	6130-212	69,0	82,0
3"	6130-300	78,0	95,5

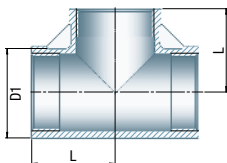

130 T-Stück 90° I/I/I, reduziert

Mat. 1.4408



Größe [1 x 2]	Artikel-Nr.	Abmessungen [mm]			
		L	L1	D1	D2
1/4" x 1/8"	6130-014018	18,0	18,0	16,0	13,0
3/8" x 1/4"	6130-038014	20,0	22,0	20,0	16,0
1/2" x 1/4"	6130-012014	24,0	24,0	24,5	16,0
1/2" x 3/8"	6130-012038	26,0	25,0	24,5	20,0
3/4" x 3/8"	6130-034038	28,0	28,0	30,0	20,0
3/4" x 1/2"	6130-034012	29,0	30,0	30,0	24,5
1" x 1/2"	6130-100012	32,0	33,0	37,5	24,5
1" x 3/4"	6130-100034	34,0	35,0	37,5	30,0
1 1/4" x 3/4"	6130-114034	38,0	40,0	46,5	30,0
1 1/4" x 1"	6130-114100	40,0	42,0	46,5	37,5
1 1/2" x 3/4"	6130-112034	37,0	43,0	53,0	30,0
1 1/2" x 1"	6130-112100	41,0	45,0	53,0	37,5
1 1/2" x 1 1/4"	6130-112114	45,0	48,0	53,0	46,5
2" x 1"	6130-200100	44,0	51,0	65,5	37,5
2" x 1 1/4"	6130-200114	48,0	54,0	65,5	46,5
2" x 1 1/2"	6130-200112	52,0	55,0	65,5	53,0

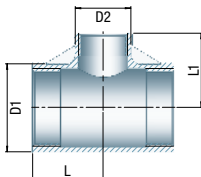

180 Kreuzstück, I/I/I/I, 4 Seiten gleich

Mat. 1.4408

Größe [1 x 2]	Artikel-Nr.	Abmessungen [mm]	
		L	D1
1/8"	6180-018	17,0	13,0
1/4"	6180-014	19,0	16,0
3/8"	6180-038	23,0	20,0
1/2"	6180-012	27,0	24,5
3/4"	6180-034	32,0	30,0
1"	6180-100	38,0	37,5
1 1/4"	6180-114	45,0	46,5
1 1/2"	6180-112	48,0	53,0
2"	6180-200	57,0	65,5

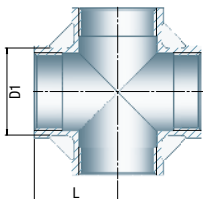

220 Y-Verteiler, I/I/I

Mat. 1.4408

Größe [1 x 2]	Artikel-Nr.	Abmessungen [mm]	
		L	D1
1/4"	6220-014	19,0	16,0
3/8"	6220-038	23,0	20,0
1/2"	6220-012	27,0	24,5
3/4"	6220-034	32,0	30,0
1"	6220-100	38,0	37,5
1 1/4"	6220-114	45,0	46,5
1 1/2"	6220-112	48,0	53,0
2"	6220-200	57,0	65,5

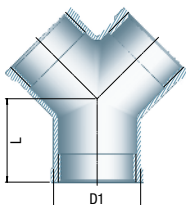

240 Reduziermuffe, I/I

Mat. 1.4408

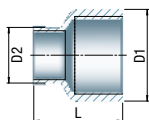

Größe [1 x 2]	Artikel-Nr.	Abmessungen [mm]		
		L	D1	D2
1/4" x 1/8"	6240-014018	25,0	16,5	13,0
3/8" x 1/8"	6240-038018	23,0	20,0	13,0
3/8" x 1/4"	6240-038014	26,0	20,0	16,5
1/2" x 1/8"	6240-012018	34,0	25,5	13,0
1/2" x 1/4"	6240-012014	34,0	25,5	16,5
1/2" x 3/8"	6240-012038	34,0	25,5	20,0
3/4" x 1/8"	6240-034018	36,0	31,0	13,0
3/4" x 1/4"	6240-034014	36,0	31,0	16,5
3/4" x 3/8"	6240-034038	36,0	31,0	20,0
3/4" x 1/2"	6240-034012	36,0	31,0	24,7
1" x 3/8"	6240-100038	42,0	38,0	20,0
1" x 1/2"	6240-100012	42,0	38,0	24,7
1" x 3/4"	6240-100034	42,0	38,0	31,0
1 1/4" x 1/2"	6240-114012	48,0	47,0	24,5
1 1/4" x 3/4"	6240-114034	48,0	47,0	31,0
1 1/4" x 1"	6240-114100	48,0	47,0	38,0
1 1/2" x 1/2"	6240-112012	52,0	53,0	24,7
1 1/2" x 3/4"	6240-112034	52,0	53,0	30,0
1 1/2" x 1"	6240-112100	52,0	54,0	38,0
1 1/2" x 1 1/4"	6240-112114	52,0	54,0	47,0
2" x 1/2"	6240-200012	58,0	66,0	24,7
2" x 3/4"	6240-200034	58,0	66,0	30,0
2" x 1"	6240-200100	58,0	66,0	38,0
2" x 1 1/4"	6240-200114	58,0	66,0	47,0
2" x 1 1/2"	6240-200112	58,0	66,0	54,0
2 1/2" x 1 1/2"	6240-212112	65,0	82,0	54,0
2 1/2" x 2"	6240-212200	65,0	82,0	66,0
3" x 2"	6240-300200	72,0	96,5	66,0
3" x 2 1/2"	6240-300212	72,0	96,5	82,0
4" x 2"	6240-400200	94,0	123,5	66,0
4" x 2 1/2"	6240-400212	94,0	123,5	82,0
4" x 3"	6240-400300	94,0	123,5	96,5

241 Reduziernippel, A/I

Mat. 1.4408

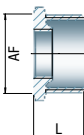

Größe [1 x 2]	Artikel-Nr.	Abmessungen [mm]	
		L	AF
1/4" x 1/8"	6241-014018	16,0	14,0
3/8" x 1/8"	6241-038018	16,5	18,0
3/8" x 1/4"	6241-038014	16,5	18,0
1/2" x 1/8"	6241-012018	20,0	22,0
1/2" x 1/4"	6241-012014	20,0	22,0
1/2" x 3/8"	6241-012038	20,0	22,0
3/4" x 1/8"	6241-034018	21,0	27,5
3/4" x 1/4"	6241-034014	21,0	27,5
3/4" x 3/8"	6241-034038	21,0	27,5
3/4" x 1/2"	6241-034012	21,0	27,5
1" x 1/4"	6241-100014	24,5	34,5
1" x 3/8"	6241-100038	24,5	34,5
1" x 1/2"	6241-100012	24,0	34,5
1" x 3/4"	6241-100034	24,0	34,5
1 1/4" x 3/8"	6241-114038	27,5	43,0
1 1/4" x 1/2"	6241-114012	27,5	43,0
1 1/4" x 3/4"	6241-114034	27,0	43,0
1 1/4" x 1"	6241-114100	27,0	43,0
1 1/2" x 3/8"	6241-112038	28,5	49,0
1 1/2" x 1/2"	6241-112012	28,5	49,0
1 1/2" x 3/4"	6241-112034	28,5	49,0

Größe [1 x 2]	Artikel-Nr.	Abmessungen [mm]	
		L	AF
1 1/2" x 1"	6241-112100	28,5	49,0
1 1/2" x 1 1/4"	6241-112114	28,5	49,0
2" x 1/2"	6241-200012	33,0	61,0
2" x 3/4"	6241-200034	33,0	61,0
2" x 1"	6241-200100	33,0	61,0
2" x 1 1/4"	6241-200114	32,0	61,0
2" x 1 1/2"	6241-200112	32,0	61,0
2 1/2" x 1"	6241-212100	37,0	76,0
2 1/2" x 1 1/4"	6241-212114	37,0	76,0
2 1/2" x 1 1/2"	6241-212112	37,0	76,0
2 1/2" x 2"	6241-212200	37,0	76,0
3" x 1 1/4"	6241-300114	40,0	90,0
3" x 1 1/2"	6241-300112	40,0	90,0
3" x 2"	6241-300200	40,0	90,0
3" x 2 1/2"	6241-300212	40,0	90,0
4" x 2"	6241-400200	46,0	115,0
4" x 2 1/2"	6241-400212	45,0	115,0
4" x 3"	6241-400300	45,0	115,0

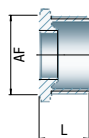

245 Reduzierdoppelnippel, A/A

Mat. 1.4408

Größe [1 x 2]	Artikel-Nr.	Abmessungen [mm]		
		d1	d2	AF
1/4" x 1/8"	6245-014018	8,0	5,5	15,0
3/8" x 1/8"	6245-038018	11,5	5,5	18,0
3/8" x 1/4"	6245-038014	11,5	8,0	18,0
1/2" x 1/8"	6245-012018	15,0	5,5	22,0
1/2" x 1/4"	6245-012014	15,0	8,0	22,0
1/2" x 3/8"	6245-012038	15,0	11,5	22,0
3/4" x 1/4"	6245-034014	20,5	8,0	28,0
3/4" x 3/8"	6245-034038	20,5	11,5	28,0
3/4" x 1/2"	6245-034012	20,5	15,0	28,0
1" x 1/4"	6245-100014	26,0	8,0	35,0
1" x 3/8"	6245-100038	26,0	11,5	35,0
1" x 1/2"	6245-100012	26,0	15,0	35,0
1" x 3/4"	6245-100034	26,0	20,5	35,0
1 1/4" x 1/2"	6245-114012	34,5	15,0	43,5
1 1/4" x 3/4"	6245-114034	34,5	20,5	43,5
1 1/4" x 1"	6245-114100	34,5	26,0	43,5
1 1/2" x 1/2"	6245-112012	40,0	15,0	49,5
1 1/2" x 3/4"	6245-112034	40,0	20,5	49,5
1 1/2" x 1"	6245-112100	40,0	26,0	49,5
1 1/2" x 1 1/4"	6245-112114	40,0	34,5	49,5
2" x 1/2"	6245-200012	51,0	15,0	62,0
2" x 3/4"	6245-200034	51,0	20,5	62,0
2" x 1"	6245-200100	51,0	26,0	62,0
2" x 1 1/4"	6245-200114	51,0	34,5	62,0
2" x 1 1/2"	6245-200112	51,0	40,0	62,0
2 1/2" x 1 1/2"	6245-212112	65,5	40,0	77,5
2 1/2" x 2"	6245-212200	65,5	51,0	77,5
3" x 1 1/2"	6245-300112	77,5	40,0	77,5
3" x 2"	6245-300200	77,5	51,0	90,5
3" x 2 1/2"	6245-300212	77,5	65,5	90,5
4" x 2"	6245-400200	101,5	51,0	90,5
4" x 2 1/2"	6245-400212	101,5	65,5	116,0
4" x 3"	6245-400300	101,5	77,5	116,0

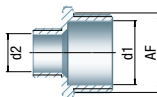

270 Muffe, I/I, beide Seiten gleich

Mat. 1.4404

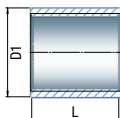

Größe [1 x 2]	Artikel-Nr.	Abmessungen [mm]	
		L	D1
1/8"	6270-018	17,0	13,0
1/4"	6270-014	24,0	16,5
3/8"	6270-038	25,0	20,0
1/2"	6270-012	32,0	24,5
3/4"	6270-034	35,0	30,0
1"	6270-100	41,0	37,5
1 1/4"	6270-114	45,0	46,5
1 1/2"	6270-112	45,0	53,0
2"	6270-200	54,0	65,5
2 1/2"	6270-212	63,0	82,0
3"	6270-300	69,0	95,5
4"	6270-400	81,0	121,5

272 halbe Muffe, I/I, beide Seiten gleich

Mat. 1.4404

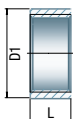

Größe [1 x 2]	Artikel-Nr.	Abmessungen [mm]	
		L	D1
1/8"	6272-018	7,5	13,0
1/4"	6272-014	11,0	18,5
3/8"	6272-038	11,5	20,0
1/2"	6272-012	15,0	24,5
3/4"	6272-034	16,5	30,0
1"	6272-100	19,5	37,5
1 1/4"	6272-114	21,5	46,5
1 1/2"	6272-112	21,5	53,0
2"	6272-200	26,0	65,5
2 1/2"	6272-212	30,5	82,0
3"	6272-300	33,5	95,5
4"	6272-400	39,5	121,5

280 Sechskant-Doppelnippel, A/A

Mat. 1.4408

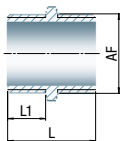

Größe [1 x 2]	Artikel-Nr.	Abmessungen [mm]		
		L	L1	AF
1/8"	6280-018	20,0	8,0	11,0
1/4"	6280-014	25,0	10,5	15,0
3/8"	6280-038	27,0	11,0	18,0
1/2"	6280-012	34,0	14,5	22,0
3/4"	6280-034	36,5	15,5	28,0
1"	6280-100	42,0	18,0	35,0
1 1/4"	6280-114	47,5	20,5	43,5
1 1/2"	6280-112	47,5	20,5	49,5
2"	6280-200	57,0	25,0	62,0
2 1/2"	6280-212	61,0	27,0	77,5
3"	6280-300	67,5	30,0	90,5
4"	6280-400	80,0	36,0	117,0

290 Sechskantstopfen

Mat. 1.4408

Größe [1 x 2]	Artikel-Nr.	Abmessungen [mm]	
		L	AF
1/8"	6290-018	12,0	11,0
1/4"	6290-014	14,5	15,0
3/8"	6290-038	16,0	18,0
1/2"	6290-012	19,5	22,0
3/4"	6290-034	21,0	28,0
1"	6290-100	24,0	35,0
1 1/4"	6290-114	27,0	43,5
1 1/2"	6290-112	27,0	49,5
2"	6290-200	32,0	62,0
2 1/2"	6290-212	34,0	77,5
3"	6290-300	37,5	90,5
4"	6290-400	44,0	117,0

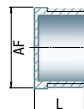

291 Vierkant-Stopfen, ohne Rand

Mat. 1.4408

Größe [1 x 2]	Artikel-Nr.	Abmessungen [mm]	
		L	AF
1/8"	6291-018	13,0	6,0
1/4"	6291-014	15,5	7,0
3/8"	6291-038	16,0	8,0
1/2"	6291-012	20,5	10,0
3/4"	6291-034	21,5	12,0
1"	6291-100	25,0	14,0
1 1/4"	6291-114	27,5	16,0
1 1/2"	6291-112	28,5	20,0
2"	6291-200	33,0	22,0
2 1/2"	6291-212	37,0	28,0
3"	6291-300	42,0	32,0
4"	6291-400	48,0	40,0

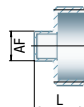

300 Kappe, Sechskant

Mat. 1.4408

Größe [1 x 2]	Artikel-Nr.	Abmessungen [mm]	
		L	AF
1/8"	6300-018	13,5	13,5
1/4"	6300-014	17,0	17,0
3/8"	6300-038	17,5	20,5
1/2"	6300-012	21,0	25,0
3/4"	6300-034	22,5	31,0
1"	6300-100	26,0	38,0
1 1/4"	6300-114	29,0	47,0
1 1/2"	6300-112	29,0	53,0
2"	6300-200	33,5	66,0
2 1/2"	6300-212	38,5	82,0
3"	6300-300	42,0	95,5
4"	6300-400	48,5	121,5

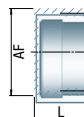

310 Gegenmutter

Mat. 1.4408

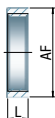

Größe [1 x 2]	Artikel-Nr.	Abmessungen [mm]	
		L	AF
1/8"	6310-018	5,0	15,0
1/4"	6310-014	6,0	18,0
3/8"	6310-038	6,0	22,0
1/2"	6310-012	7,0	27,0
3/4"	6310-034	7,0	32,0
1"	6310-100	9,0	40,0
1 1/4"	6310-114	11,0	48,0
1 1/2"	6310-112	11,0	55,0
2"	6310-200	13,0	68,0
2 1/2"	6310-212	15,0	85,0
3"	6310-300	17,0	100,0
4"	6310-400	20,0	125,0

315 Sechskant Schlauchtülle

Mat. 1.4408



Größe [1 x 2]	Artikel-Nr.	Abmessungen [mm]					
		L	L1	d1	d2	AF	
1/8" x 7 mm	6315-1807	38,0	26,0	4,0	8,0	11,0	
1/4" x 9 mm	6315-1409	42,5	28,0	5,0	9,0	15,0	
3/8" x 11 mm	6315-3811	49,0	33,0	7,0	11,5	18,0	
1/2" x 13 mm	6315-1213	57,5	38,0	10,5	15,0	22,0	
3/4" x 20 mm	6315-3420	66,0	45,0	15,0	20,0	28,0	
1" x 25 mm	6315-1025	76,0	52,0	22,0	27,0	35,0	
1 1/4" x 33 mm	6315-11433	79,0	52,0	27,5	33,0	43,5	
1 1/2" x 40 mm	6315-11240	83,0	56,0	34,0	39,5	49,5	
2" x 52 mm	6315-2052	92,0	60,0	45,0	52,0	62,0	
2 1/2" x 63,5 mm	6315-212635	99,0	65,0	59,0	67,0	77,5	
3" x 76,5 mm	6315-30765	107,5	70,0	71,0	80,0	90,5	
4" x 100 mm	6315-40100	117,0	73,0	95,0	105,0	117,0	

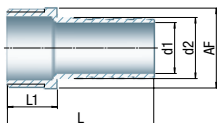

330 Verschraubung, I/I, flach dichtend

Mat. 1.4408

Größe [1 x 2]	Artikel-Nr.	Abmessungen [mm]	
		L	L1
1/8"	6330-018	30,0	13,0
1/4"	6330-014	33,5	13,5
3/8"	6330-038	36,5	15,0
1/2"	6330-012	39,5	16,0
3/4"	6330-034	42,5	17,0
1"	6330-100	50,0	20,0
1 1/4"	6330-114	54,0	22,0
1 1/2"	6330-112	58,0	24,0
2"	6330-200	65,0	27,0
2 1/2"	6330-212	75,0	29,5
3"	6330-300	83,0	31,0
4"	6330-400	110,0	34,0

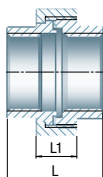

331 Verschraubung, A/I, flach dichtend

Mat. 1.4408

Größe [1 x 2]	Artikel-Nr.	Abmessungen [mm]	
		L	L1
1/8"	6331-018	38,0	13,0
1/4"	6331-014	44,0	13,5
3/8"	6331-038	47,5	15,0
1/2"	6331-012	54,0	16,0
3/4"	6331-034	58,0	17,0
1"	6331-100	68,0	20,0
1 1/4"	6331-114	74,5	22,0
1 1/2"	6331-112	78,5	24,0
2"	6331-200	90,0	27,0
2 1/2"	6331-212	102,0	29,5
3"	6331-300	113,0	31,0

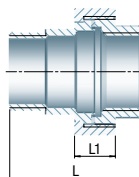

332 Verschraubung Schweißende/Schweißende, flach dichtend

Mat. 1.4408



Größe [1 x 2]	Artikel-Nr.	Abmessungen [mm]			
		L	L1	D1	d2
1/4"	6332-014	35,5	13,5	13,5	8,8
3/8"	6332-038	38,0	15,0	17,2	12,5
1/2"	6332-012	44,0	16,0	21,3	16,0
3/4"	6332-034	45,0	17,0	26,9	21,6
1"	6332-100	50,0	20,0	33,7	27,2
1 1/4"	6332-114	55,0	22,0	42,4	35,9
1 1/2"	6332-112	57,0	24,0	48,3	41,8
2"	6332-200	65,0	27,0	60,3	53,0
2 1/2"	6332-212	71,0	29,5	76,1	68,8
3"	6332-300	80,0	31,0	88,9	80,8

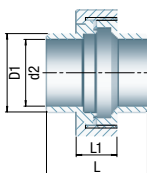

333 Verschraubung A-Gew./Schweißende, flach dichtend

Mat. 1.4408



Größe [1 x 2]	Artikel-Nr.	Abmessungen [mm]			
		L	L1	D1	d2
1/4"	6333-014	45,0	13,5	13,5	8,8
3/8"	6333-038	48,8	15,0	17,2	12,5
1/2"	6333-012	56,3	16,0	21,3	16,0
3/4"	6333-034	59,3	17,0	26,9	21,6
1"	6333-100	69,0	20,0	33,7	27,2
1 1/4"	6333-114	74,5	22,0	42,4	35,9
1 1/2"	6333-112	78,0	24,0	48,3	41,8
2"	6333-200	96,0	27,0	60,3	53,0
2 1/2"	6333-212	99,3	29,5	76,1	68,8

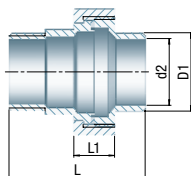

334 Verschraubung I-Gew./Schweißende, flach dichtend

Mat. 1.4408

Größe [1 x 2]	Artikel-Nr.	Abmessungen [mm]			
		L	L1	D1	d2
1/4"	6334-014	34,5	13,5	13,5	8,8
3/8"	6334-038	37,8	15,0	17,2	12,5
1/2"	6334-012	41,8	16,0	21,3	16,0
3/4"	6334-034	43,8	17,0	26,9	21,6
1"	6334-100	51,0	20,0	33,7	27,2
1 1/4"	6334-114	54,0	22,0	42,4	35,9
1 1/2"	6334-112	57,5	24,0	48,3	41,8
2"	6334-200	71,0	27,0	60,3	53,0

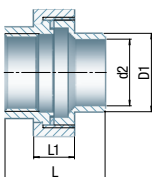

335 Verschraubung, A/A, flach dichtend

Mat. 1.4408

Größe [1 x 2]	Artikel-Nr.	Abmessungen [mm]	
		L	L1
1/2"	6335-012	68,5	16,0
3/4"	6335-034	73,5	17,0
1"	6335-100	86,0	20,0
1 1/4"	6335-114	95,0	22,0
1 1/2"	6335-112	99,0	24,0

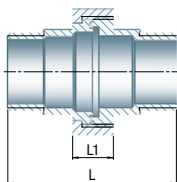

340 Verschraubung, I/I, konisch dichtend Mat. 1.4408



Größe [1 x 2]	Artikel-Nr.	Abmessungen [mm]	
		L	L1
1/8"	6340-018	30,0	13,0
1/4"	6340-014	33,5	13,5
3/8"	6340-038	36,5	15,0
1/2"	6340-012	39,5	16,0
3/4"	6340-034	42,5	17,0
1"	6340-100	50,0	20,0
1 1/4"	6340-114	54,0	22,0
1 1/2"	6340-112	58,0	24,0
2"	6340-200	65,0	27,0
2 1/2"	6340-212	75,0	29,5
3"	6340-300	83,0	31,0
4"	6340-400	110,0	34,0

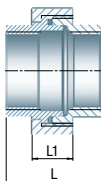

341 Verschraubung, A/I, konisch dichtend Mat. 1.4408



Größe [1 x 2]	Artikel-Nr.	Abmessungen [mm]	
		L	L1
1/8"	6341-018	38,0	13,0
1/4"	6341-014	44,0	13,5
3/8"	6341-038	47,5	15,0
1/2"	6341-012	54,0	16,0
3/4"	6341-034	58,0	17,0
1"	6341-100	68,0	20,0
1 1/4"	6341-114	74,5	22,0
1 1/2"	6341-112	78,5	24,0
2"	6341-200	90,0	27,0
2 1/2"	6341-212	102,0	29,5
3"	6341-300	113,0	31,0

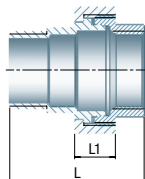

342 Verschraubung, Schweißende/Schweißende, konisch dichtend

Mat. 1.4408

Größe [1 x 2]	Artikel-Nr.	Abmessungen [mm]			
		L	L1	D1	d2
1/4"	6342-014	35,5	13,5	13,5	8,8
3/8"	6342-038	38,0	15,0	17,2	12,5
1/2"	6342-012	44,0	16,0	21,3	16,0
3/4"	6342-034	45,0	17,0	26,9	21,6
1"	6342-100	50,0	20,0	33,7	27,2
1 1/4"	6342-114	55,0	22,0	42,4	35,9
1 1/2"	6342-112	57,0	24,0	48,3	41,8
2"	6342-200	65,0	27,0	60,3	53,0
2 1/2"	6342-212	71,0	29,5	76,1	68,8
3"	6342-300	80,0	31,0	88,9	80,8

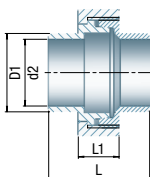

343 Verschraubung, A-Gew./Schweißende, konisch dichtend

Mat. 1.4408

Größe [1 x 2]	Artikel-Nr.	Abmessungen [mm]			
		L	L1	D1	d2
1/4"	6343-014	45,0	13,5	13,5	8,8
3/8"	6343-038	48,8	15,0	17,2	12,5
1/2"	6343-012	56,3	16,0	21,3	16,0
3/4"	6343-034	59,3	17,0	26,9	21,6
1"	6343-100	69,0	20,0	33,7	27,2
1 1/4"	6343-114	74,5	22,0	42,4	35,9
1 1/2"	6343-112	78,0	24,0	48,3	41,8
2"	6343-200	96,0	27,0	60,3	53,0

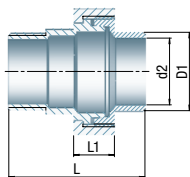

344 Verschraubung, I-Gew./Schweißende, konisch dichtend

Mat. 1.4408



Größe [1 x 2]	Artikel-Nr.	Abmessungen [mm]			
		L	L1	D1	d2
1/4"	6344-014	34,5	13,5	13,5	8,8
3/8"	6344-038	37,8	15,0	17,2	12,5
1/2"	6344-012	41,8	16,0	21,3	16,0
3/4"	6344-034	43,8	17,0	26,9	21,6
1"	6344-100	51,0	20,0	33,7	27,2
1 1/4"	6344-114	54,0	22,0	42,4	35,9
1 1/2"	6344-112	57,5	24,0	48,3	41,8
2"	6344-200	71,0	27,0	60,3	53,0

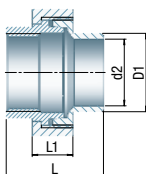

345 Verschraubung, A/A, konisch dichtend Mat. 1.4408





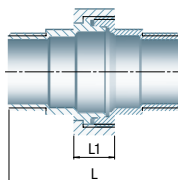

Größe [1 x 2]	Artikel-Nr.	Abmessungen [mm]	
		L	L1
1/2"	6345-012	68,5	16,0
3/4"	6345-034	73,5	17,0
1"	6345-100	86,0	20,0
2"	6345-200	115,0	27,0



DICHTUNGEN

PTFE Dichtungen für flachdichtende Verschraubungen

Verschraubungsgröße	Artikel-Nr.	Dichtungsabmessung [mm]
1/8"	633-018	19,0 x 13,5 x 2
1/4"	633-014	23,0 x 17,5 x 2
3/8"	633-038	27,0 x 17,5 x 2
1/2"	633-012	30,0 x 23,5 x 2
3/4"	633-034	38,0 x 30,5 x 2
1"	633-100	44,3 x 38,5 x 2
1 1/4"	633-114	55,5 x 47,5 x 2
1 1/2"	633-112	61,5 x 53,5 x 2
2"	633-200	77,0 x 65,6 x 2
2 1/2"	633-212	95,5 x 85,5 x 2
3"	633-300	108,0 x 96,5 x 2
4"	633-400	133,0 x 120,5 x 2

-  Reduzierter Durchgang mit Innengewinde und Schließblase
-  Ausblassichere Spindel
-  Feinguss Gehäuse
-  **Druckstufen: 1000 lbs (69 bar)**

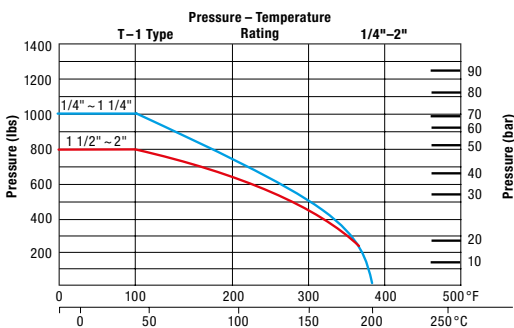

603 Einteiliger Kugelhahn, reduzierter Durchgang mit Innengewinde und Schließblase

Mat. 1.4408

Abmessungen [mm]

Größe	Artikel-Nr.	d	L	L1	H	W	S
1/4"	603-014	5,0	39,0	19,0	30,0	70,0	17,0
3/8"	603-038	6,5	44,0	21,0	34,0	90,0	21,0
1/2"	603-012	9,2	56,5	27,5	41,0	100,0	25,0
3/4"	603-034	12,5	59,0	29,0	44,0	100,0	32,0
1"	603-100	15,0	71,0	34,5	50,0	110,0	38,0
1 1/4"	603-114	20,0	78,0	37,0	55,0	110,0	48,0
1 1/2"	603-112	25,0	83,0	40,0	64,0	135,0	53,0
2"	603-200	32,0	100,0	49,0	70,0	145,0	65,0

Edelstahl Einteiliger Kugelhahn

Typ 603 1/4"-2"

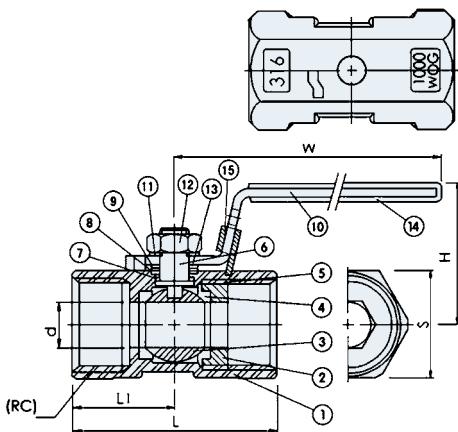

Nr.	Teile	Anzahl	Material CF8M
1	Gehäuse	1	ASTM - A351 - CF8M
2	Kugerverschluss	1	ASTM - A351 - CF8M
3	Kugel	1	ASTM - A351 - CF8M
4	Kugeldichtung	2	PTFE
5	Dichtung	1	PTFE
6	Spindel	1	AISI 316
7	Unterlegscheibe	1	PTFE
8	Spindeldichtung	1	PTFE
9	Spindelscheibe	1	AISI 304
10	Griff	1	AISI 304
11	Federring	1	AISI 304
12	Spindelbuchse	1	AISI 304
13	Druckring	1	AISI 304
14	Kunststoffabdeckung	1	PLASTIC
15	Schließblase	1	AISI 304

- Voller Durchgang, Baulänge DIN 3202 M3, mit Innengewinde und Schließblase
- Ausblässichere Spindel
- Feinguss Gehäuse
- Druckstufen:** 1000 lbs (69 bar)

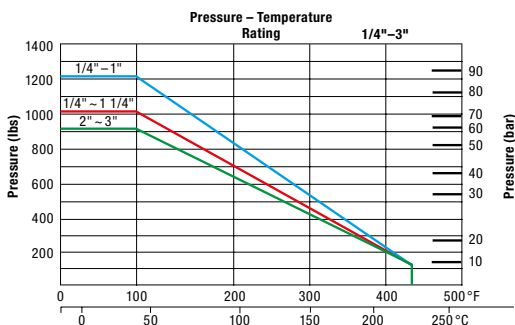

604 Zweiteiliger Kugelhahn, voller Durchgang, Baulänge DIN 3202 M3, mit Innengewinde und Schließblase

Mat. 1.4408

Größe		Abmessungen [mm]					
DN	Artikel-Nr.	d	L	H	W	N	P
1/4"	604-014	11,6	50,0	52,0	102,0	12,7	28,5
3/8"	604-038	12,7	60,0	54,0	102,0	12,7	28,5
1/2"	604-012	15,0	75,0	62,0	123,0	12,7	28,5
3/4"	604-034	20,0	80,0	66,0	123,0	21,0	35,0
1"	604-100	25,0	90,0	77,0	153,0	21,0	35,0
1 1/4"	604-114	32,0	110,0	80,0	153,0	23,5	38,0
1 1/2"	604-112	38,0	120,0	91,0	183,0	23,5	38,0
2"	604-200	50,0	140,0	98,0	183,0	23,5	38,0
2 1/2"	604-212	65,0	185,0	138,0	246,0	35,0	54,0
3"	604-300	80,0	205,0	149,0	246,0	35,0	54,0

Edelstahl Zweiteiliger Kugelhahn

Typ 604 1/4"-3"

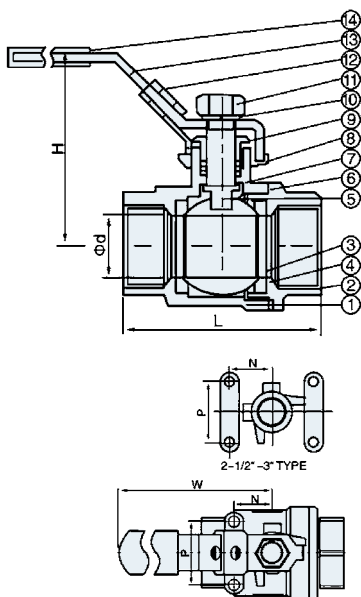

Nr. Teile	Material
1 Gehäuse	WCB - CF8M
2 Kugelverschluss	WCB - CF8M
3 Kugel	CF8M
4 Kugeldichtung	PTFE
5 Spindel	SUS 316
6 Dichtung	PTFE
7 Unterlegscheibe	PTFE
8 Spindeldichtung	PTFE
9 Buchse	AISI 304
10 Federring	AISI 304
11 Spindelbuchse	AISI 304
12 Schließblase	AISI 304
13 Griff	AISI 304
14 Kunststoffabdeckung	PLASTIC

- Voller Durchgang mit Innengewinde
- Ausblassichere Spindel
- Feinguss Gehäuse
- **Druckstufen:** 1000 lbs (69 bar)

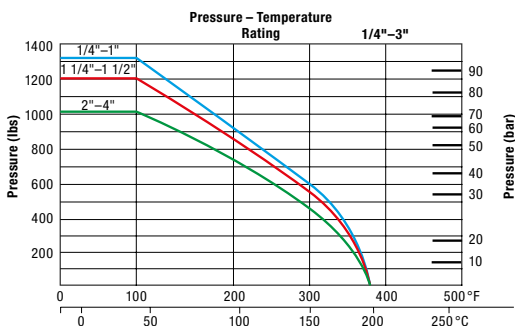

605 Zweiteiliger Eco-Kugelhahn, voller Durchgang mit Innengewinde

Mat. 1.4408

Abmessungen [mm]

Größe	Artikel-Nr.	L	D	H	W
1/4"	605-014	49,0	12,8	51,0	95,0
3/8"	605-038	49,0	12,8	51,0	95,0
1/2"	605-012	57,0	15,0	55,0	95,0
3/4"	605-034	65,0	20,0	59,0	110,0
1"	605-100	78,0	25,0	73,0	135,0
1 1/4"	605-114	90,5	32,0	78,0	135,0
1 1/2"	605-112	105,0	38,0	91,0	147,0
2"	605-200	127,0	50,0	99,0	165,0
2 1/2"	605-212	160,0	65,0	130,0	215,0
3"	605-300	180,0	80,0	142,0	215,0
4"	605-400	220,0	100,0	165,0	310,0

Edelstahl Zweiteiliger Eco-Kugelhahn

Typ 605 1/4"-4"

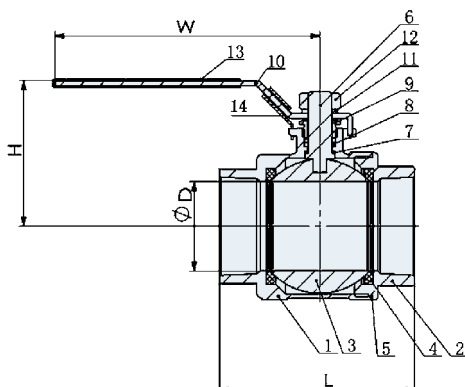

Nr.	Teile	Anzahl	Material
1	Gehäuse	1	ASTM - A351 - CF8M
2	Kugelverschluss	1	ASTM - A351 - CF8M
3	Kugel	1	ASTM - A351 - CF8M
4	Kugeldichtung	2	PTFE
5	Dichtung	1	PTFE
6	Spindel	1	AISI 316
7	Unterlegscheibe	1	PTFE
8	Spindeldichtung	2	PTFE
9	Buchsendichtung	1	AISI 304
10	Griff	1	AISI 304
11	Spindelscheibe	1	AISI 304
12	Spindelbuchse	1	AISI 304
13	Kunststoffabdeckung	1	PLASTIC
14	Schließblase	1	AISI 304

- Voller Durchgang mit Anschweißenden, Baulänge DIN 3202 S5 und Schließblase
- Ausblässichere Spindel
- Feinguss Gehäuse
- Stumpfnahende
- **Druckstufen: 1000 lbs (69 bar)**

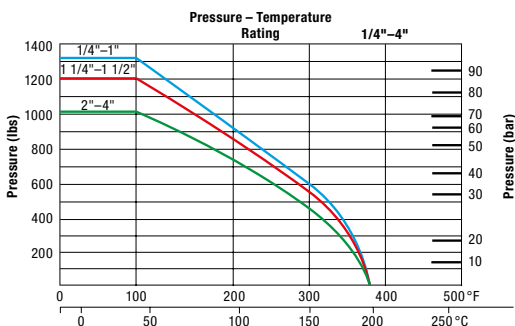

607 Dreiteiliger Kugelhahn, voller Durchgang mit Anschweißenden, Baulänge DIN 3202 S5 und Schließblase

Mat. 1.4408

Abmessungen [mm]

Größe	Artikel-Nr.	d	L	H	W	B	D
1/4" (13,5)	607-014	12,8	59,0	51,0	95,0	12,0	18,0
3/8" (17,2)	607-038	12,8	59,0	51,0	95,0	14,0	18,0
1/2" (21,3)	607-012	15,0	64,0	55,0	95,0	17,1	22,0
3/4" (26,9)	607-034	20,0	75,0	59,0	110,0	22,5	27,5
1" (33,7)	607-100	25,0	85,0	73,0	135,0	28,0	33,5
1 1/4" (42,4)	607-114	32,0	97,0	78,0	135,0	33,5	44,0
1 1/2" (48,3)	607-112	38,0	110,0	91,0	147,0	43,0	50,0
2" (60,3)	607-200	50,0	132,0	99,0	165,0	53,0	61,5
2 1/2" (76,1)	607-212	65,0	167,0	130,0	215,0	65,0	76,0
3" (88,9)	607-300	80,0	187,0	142,0	215,0	80,0	92,0
4" (114,3)	607-400	100,0	230,0	174,0	310,0	100,0	115,0

Edelstahl Dreiteiliger Kugelhahn

Typ 607 1/4"-4"

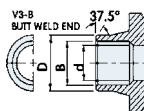
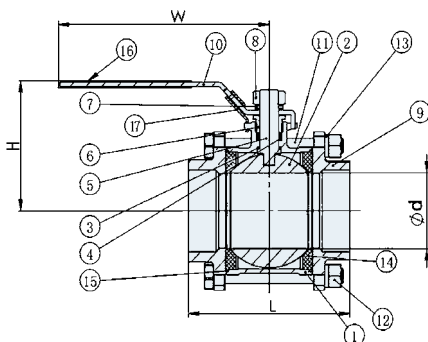

Nr.	Teile	Anzahl	Material CF8M
1	Gehäuse	1	ASTM-A351-CF8M
2	Kugel	1	ASTM-A351-CF8M
3	Unterlegscheibe	1	PTFE
4	Spindeldichtung	2	PTFE
5	Spindel	1	AISI 316
6	Buchsendichtung	1	AISI 304
7	Spindelscheibe	1	AISI 304
8	Spindelbuchse	1	AISI 304
9	Abdeckung	2	ASTM-A351-CF8M
10	Griff	1	AISI 304
11	Schraube	4-6	AISI 304
12	Sechskantschraube	4-6	AISI 304
13	Federscheibe	4-6	AISI 304
14	Kugeldichtung	2	PTFE
15	Dichtung	2	PTFE
16	Kunststoffabdeckung	1	PLASTIC
17	Schließblase	1	AISI 304

- Voller Durchgang, Baulänge DIN 3202 M3 mit Innengewinde und Schließblase
- Ausblassichere Spindel
- Feinguss Gehäuse
- **Druckstufen:** 1000 lbs (69 bar)
- **Optional:** Arretiervorrichtung

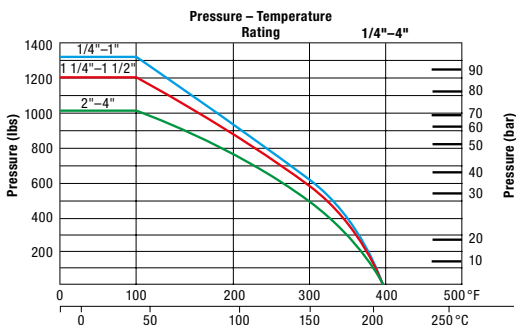

608 Dreiteiliger Kugelhahn, voller Durchgang, Baulänge DIN 3202 M3 mit Innengewinde und Schließblase

Mat. 1.4408

Abmessungen [mm]

Größe	Artikel-Nr.	Ød	L	H	W	ISO 5211		Cv Factor	Torque kgf-cm
						ØM	G		
1/4"	608-014	12,8	59,0	51,0	95,0	36,0	M5	6,6	40,0
3/8"	608-038	12,8	59,0	51,0	95,0	36,0	M5	7,9	40,0
1/2"	608-012	15,0	64,0	55,0	95,0	36,0	M5	11,2	54,0
3/4"	608-034	20,0	75,0	63,0	110,0	36,0	M5	21,0	78,0
1"	608-100	25,0	85,0	74,0	135,0	42,0	M5	35,0	106,0
1 1/4"	608-114	32,0	97,0	80,0	135,0	50,0	M6	57,0	150,0
1 1/2"	608-112	38,0	110,0	92,0	175,0	50,0	M6	80,0	200,0
2"	608-200	50,0	132,0	107,0	180,0	70,0	M8	150,0	280,0
2 1/2"	608-212	65,0	167,0	128,0	250,0	70,0	M8	265,0	500,0
3"	608-300	80,0	187,0	138,0	250,0	70,0	M8	415,0	770,0
4"	608-400	100,0	230,0	180,0	300,0	102,0	M10	780,0	1100,0

Edelstahl Dreiteiliger Kugelhahn

Typ 608 1/4"-4"

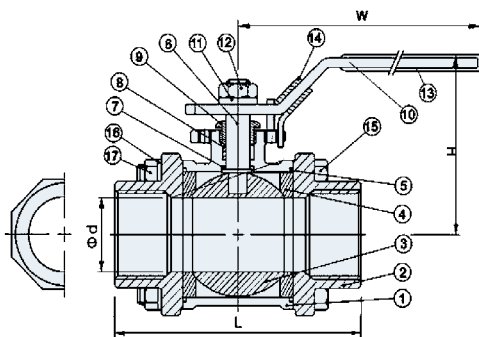

Nr.	Teile	Anzahl	Material CF8M
1	Gehäuse	1	ASTM-A351-CF8M
2	Abdeckung	2	ASTM-A351-CF8M
3	Kugel	1	ASTM-A351-CF8M
4	Kugeldichtung	2	PTFE
5	Dichtung	2	PTFE
6	Spindel	1	AISI 316
7	Dichtring	1	PTFE
8	Spindeldichtung	2	PTFE
9	Buchsendichtung	1	AISI 304
10	Griff	1	AISI 304
11	Spindelscheibe	1	AISI 304
12	Spindelbuchse	1	AISI 304
13	Kunststoffabdeckung	1	PLASTIC
14	Schließblase	1	AISI 304
15	Schraube	4 (3", 4" x 6 pcs.)	AISI 304
16	Federscheibe	4 (3", 4" x 6 pcs.)	AISI 304
17	Sechskantschraube	4 (3", 4" x 6 pcs.)	AISI 304

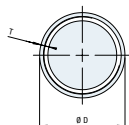
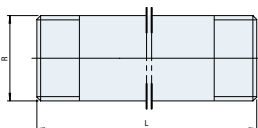

Gewindeanschluss (R) x Länge (L)	Rohr-Außen-Ø (D) x Wandstärke (T)	Artikel-Nr.
1/8" x 40 mm	10,2 x 2,0 mm	6070.040.01
1/8" x 60 mm	10,2 x 2,0 mm	6070.060.01
1/8" x 100 mm	10,2 x 2,0 mm	6070.100.01
1/4" x 30 mm	13,5 x 2,3 mm	6070.030.02
1/4" x 40 mm	13,5 x 2,3 mm	6070.040.02
1/4" x 60 mm	13,5 x 2,3 mm	6070.060.02
1/4" x 80 mm	13,5 x 2,3 mm	6070.080.02
1/4" x 100 mm	13,5 x 2,3 mm	6070.100.02
1/4" x 120 mm	13,5 x 2,3 mm	6070.120.02
1/4" x 150 mm	13,5 x 2,3 mm	6070.150.02
1/4" x 200 mm	13,5 x 2,3 mm	6070.200.02
3/8" x 40 mm	17,2 x 2,3 mm	6070.040.03
3/8" x 60 mm	17,2 x 2,3 mm	6070.060.03
3/8" x 80 mm	17,2 x 2,3 mm	6070.080.03
3/8" x 100 mm	17,2 x 2,3 mm	6070.100.03
3/8" x 120 mm	17,2 x 2,3 mm	6070.120.03
3/8" x 150 mm	17,2 x 2,3 mm	6070.150.03
3/8" x 200 mm	17,2 x 2,3 mm	6070.200.03
1/2" x 40 mm	21,3 x 2,6 mm	6070.040.04
1/2" x 60 mm	21,3 x 2,6 mm	6070.060.04
1/2" x 80 mm	21,3 x 2,6 mm	6070.080.04
1/2" x 100 mm	21,3 x 2,6 mm	6070.100.04
1/2" x 120 mm	21,3 x 2,6 mm	6070.120.04
1/2" x 150 mm	21,3 x 2,6 mm	6070.150.04
1/2" x 200 mm	21,3 x 2,6 mm	6070.200.04
1/2" x 300 mm	21,3 x 2,6 mm	6070.300.04
3/4" x 40 mm	26,9 x 2,6 mm	6070.040.05
3/4" x 60 mm	26,9 x 2,6 mm	6070.060.05
3/4" x 80 mm	26,9 x 2,6 mm	6070.080.05
3/4" x 100 mm	26,9 x 2,6 mm	6070.100.05
3/4" x 120 mm	26,9 x 2,6 mm	6070.120.05
3/4" x 150 mm	26,9 x 2,6 mm	6070.150.05
3/4" x 200 mm	26,9 x 2,6 mm	6070.200.05
3/4" x 300 mm	26,9 x 2,6 mm	6070.300.05
1" x 40 mm	33,7 x 3,2 mm	6070.040.06
1" x 60 mm	33,7 x 3,2 mm	6070.060.06
1" x 80 mm	33,7 x 3,2 mm	6070.080.06
1" x 100 mm	33,7 x 3,2 mm	6070.100.06
1" x 120 mm	33,7 x 3,2 mm	6070.120.06
1" x 150 mm	33,7 x 3,2 mm	6070.150.06
1" x 200 mm	33,7 x 3,2 mm	6070.200.06
1" x 300 mm	33,7 x 3,2 mm	6070.300.06
1 1/4" x 40 mm	42,4 x 3,2 mm	6070.040.07
1 1/4" x 60 mm	42,4 x 3,2 mm	6070.060.07
1 1/4" x 80 mm	42,4 x 3,2 mm	6070.080.07
1 1/4" x 100 mm	42,4 x 3,2 mm	6070.100.07
1 1/4" x 120 mm	42,4 x 3,2 mm	6070.120.07
1 1/4" x 150 mm	42,4 x 3,2 mm	6070.150.07
1 1/4" x 200 mm	42,4 x 3,2 mm	6070.200.07

Edelstahl Rohrdoppelnippel

Mit beidseitigem Gewinde

Mat. 1.4404



Gewindeanschluss (R) x Länge (L)	Rohr-Außen-Ø (D) x Wandstärke (T)	Artikel-Nr.
1 1/2" x 40 mm	48,3 x 3,2 mm	6070.040.08
1 1/2" x 60 mm	48,3 x 3,2 mm	6070.060.08
1 1/2" x 80 mm	48,3 x 3,2 mm	6070.080.08
1 1/2" x 100 mm	48,3 x 3,2 mm	6070.100.08
1 1/2" x 120 mm	48,3 x 3,2 mm	6070.120.08
1 1/2" x 150 mm	48,3 x 3,2 mm	6070.150.08
1 1/2" x 200 mm	48,3 x 3,2 mm	6070.200.08
2" x 40 mm	60,3 x 3,6 mm	6070.040.09
2" x 60 mm	60,3 x 3,6 mm	6070.060.09
2" x 80 mm	60,3 x 3,6 mm	6070.080.09
2" x 100 mm	60,3 x 3,6 mm	6070.100.09
2" x 120 mm	60,3 x 3,6 mm	6070.120.09
2" x 150 mm	60,3 x 3,6 mm	6070.150.09
2" x 200 mm	60,3 x 3,6 mm	6070.200.09
2 1/2" x 100 mm	76,1 x 3,6 mm	6070.100.10
2 1/2" x 120 mm	76,1 x 3,6 mm	6070.120.10
2 1/2" x 150 mm	76,1 x 3,6 mm	6070.150.10
3" x 120 mm	88,9 x 4,0 mm	6070.120.11
3" x 150 mm	88,9 x 4,0 mm	6070.150.11
3" x 200 mm	88,9 x 4,0 mm	6070.200.11
4" x 100 mm	114,3 x 4,5 mm	6070.100.12
4" x 120 mm	114,3 x 4,5 mm	6070.120.12

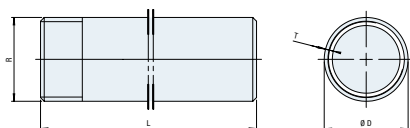

Gewindeanschluss (R) x Länge (L)	Rohr-Außen-Ø (D) x Wandstärke (T)	Artikel-Nr.
1/8" x 30 mm	10,2 x 2,0 mm	6072.030.01
1/4" x 30 mm	13,5 x 2,3 mm	6072.030.02
3/8" x 30 mm	17,2 x 2,3 mm	6072.030.03
1/2" x 35 mm	21,3 x 2,6 mm	6072.035.04
3/4" x 40 mm	26,9 x 2,6 mm	6072.040.05
1" x 40 mm	33,7 x 3,2 mm	6072.040.06
1 1/4" x 50 mm	42,4 x 3,2 mm	6072.050.07
1 1/2" x 50 mm	48,3 x 3,2 mm	6072.050.08
2" x 50 mm	60,3 x 3,6 mm	6072.050.09
2 1/2" x 60 mm	76,1 x 3,6 mm	6072.060.10
3" x 70 mm	88,9 x 4,0 mm	6072.070.11
4" x 80 mm	114,3 x 4,5 mm	6072.080.12